

El 625 x 3/4
3-1032

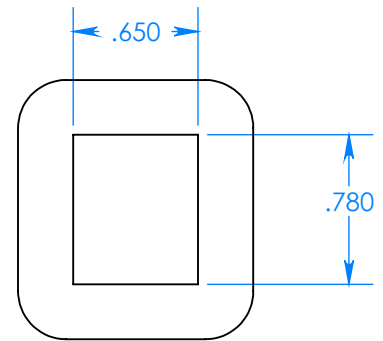
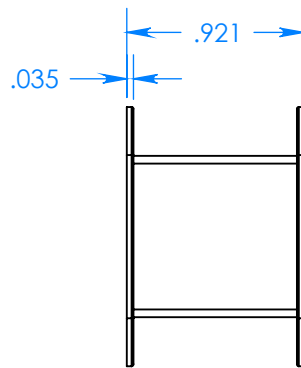
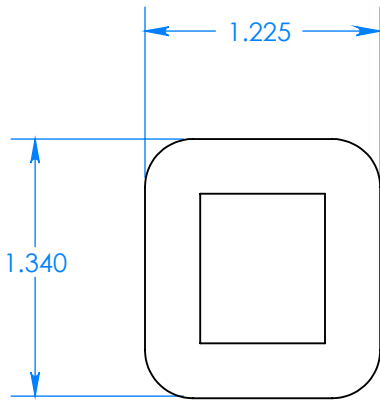
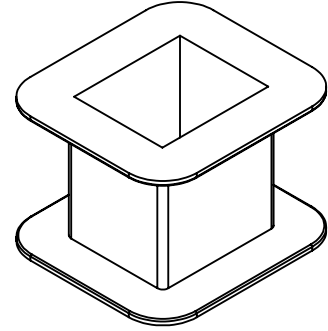

All dimensions for reference only. Samples available upon request.
Foremost Plastic Products Company, inc. Phone 1-708-452-5300
E-Mail: sales@foremostplastic.com Fax 1-708-452-0446