

El 625 x 5/8  
3-1409

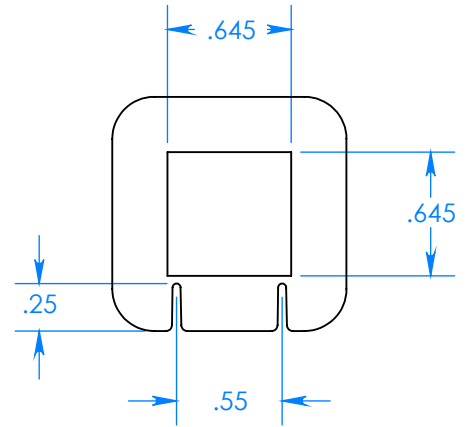
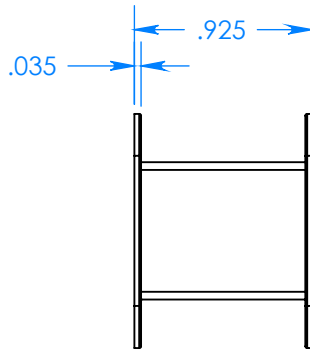
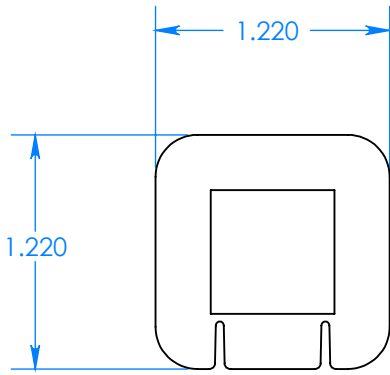
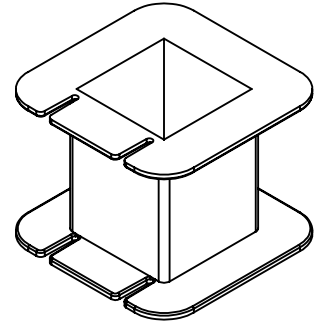

All dimensions for reference only. Samples available upon request.  
Foremost Plastic Products Company, inc. Phone 1-708-452-5300  
E-Mail: sales@foremostplastic.com Fax 1-708-452-0446