

EI 87 x 1.00  
3-2557

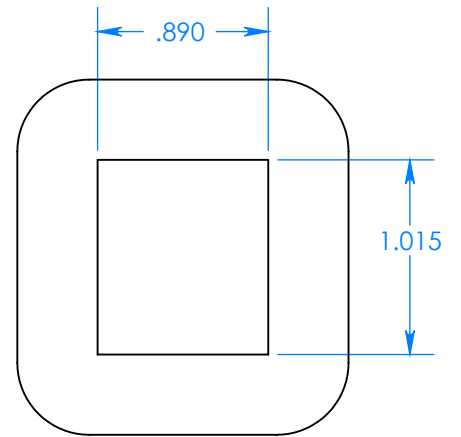
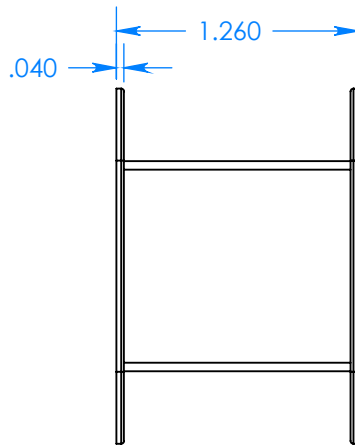
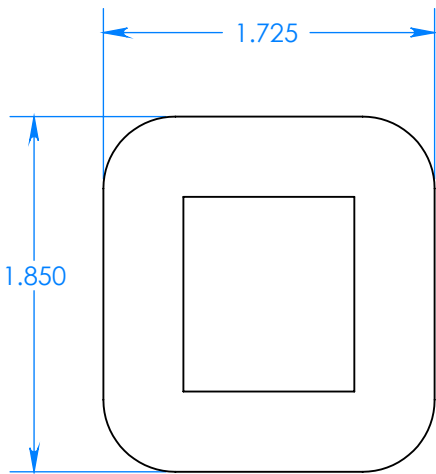
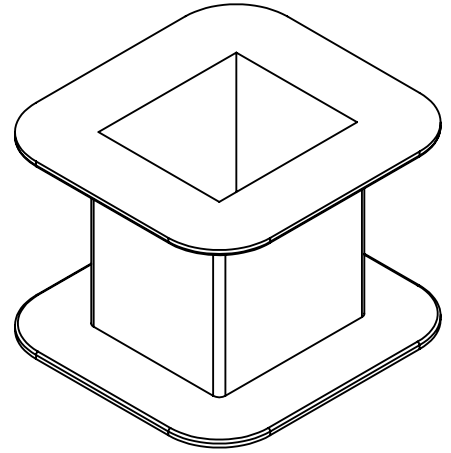

All dimensions for reference only. Samples available upon request.  
Foremost Plastic Products Company, inc. Phone 1-708-452-5300  
E-Mail: sales@foremostplastic.com Fax 1-708-452-0446