

El 75 x 3/4
5-6019

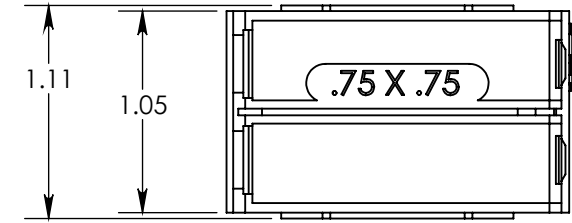

5-6017 and 6019
assembled

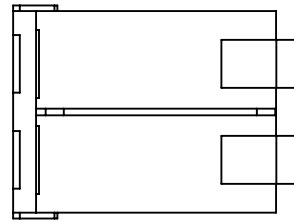
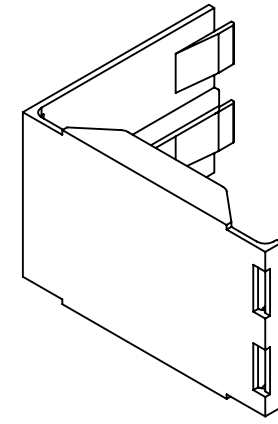
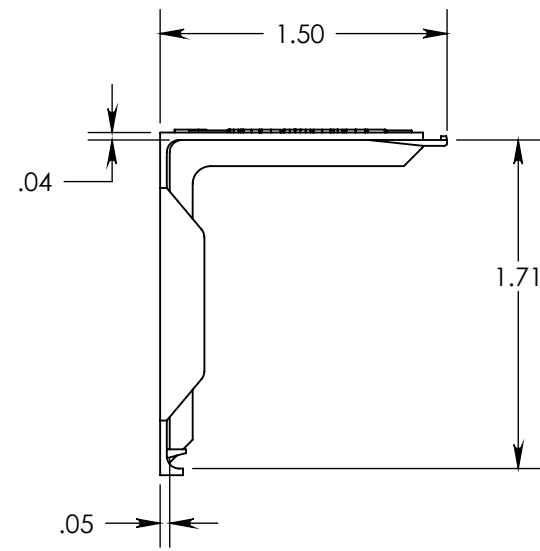
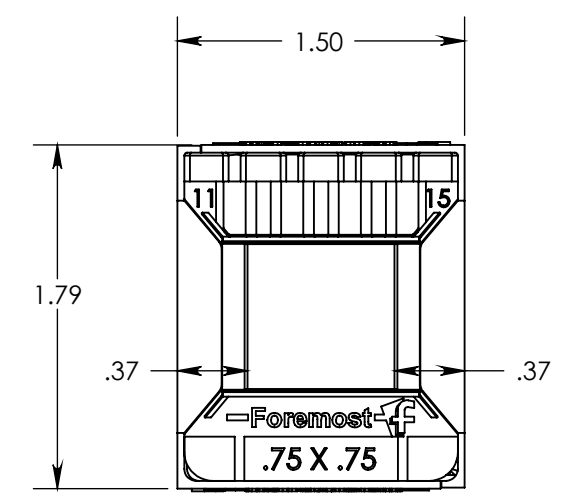
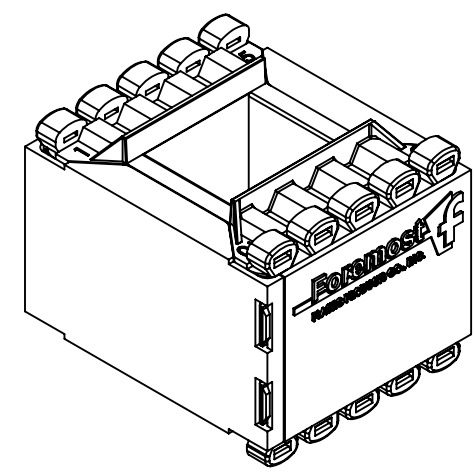
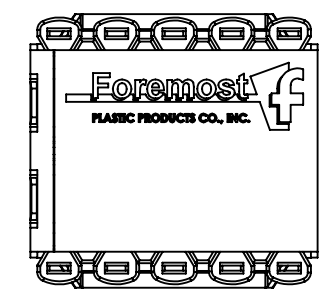
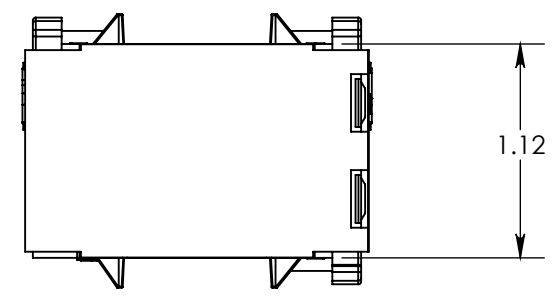

All dimensions for reference only. Samples available upon request.
Foremost Plastic Products Company, inc. Phone 1-708-452-5300
E-Mail: sales@foremostplastic.com Fax 1-708-452-0446