

EI 87 x 7/8
 5-6030 SL-SS
 Slotted, Single Section

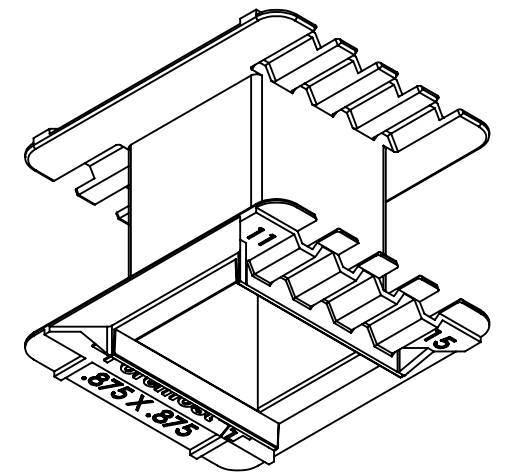
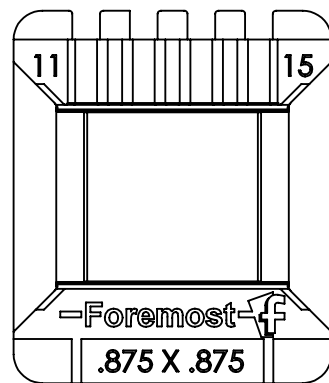
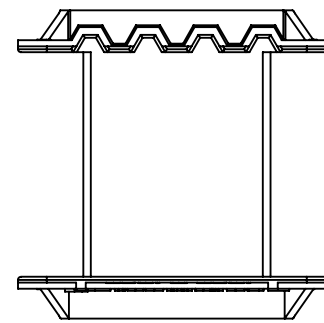
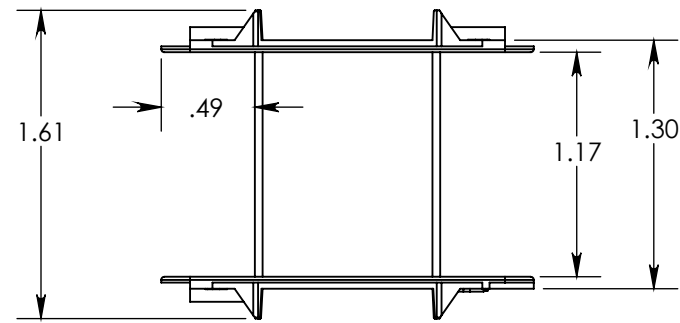
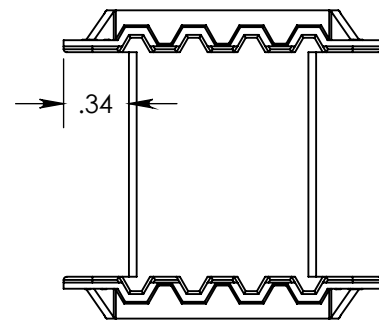
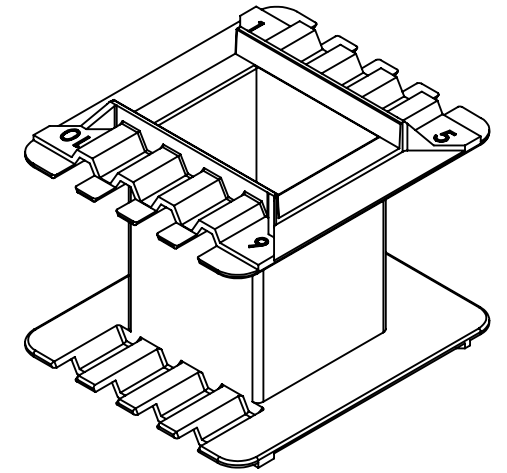
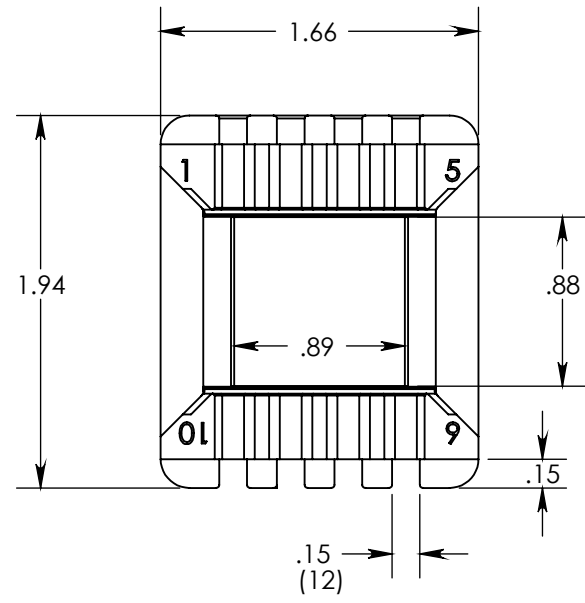

All dimensions for reference only. Samples available upon request.
 Foremost Plastic Products Company, inc. Phone 1-708-452-5300
 E-Mail: sales@foremostplastic.com Fax 1-708-452-0446