

EI 100 x 1
 5-6062 SL-SDS
 Slotted, Split Double Section

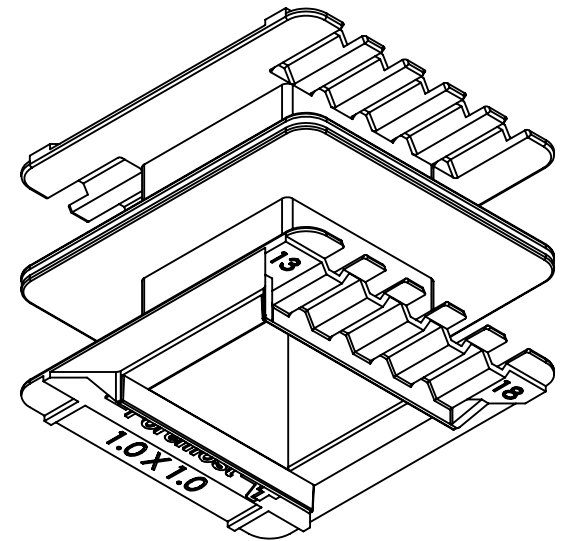
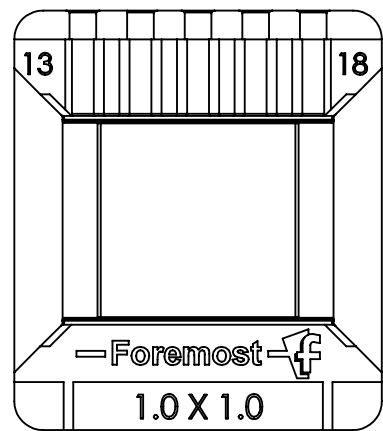
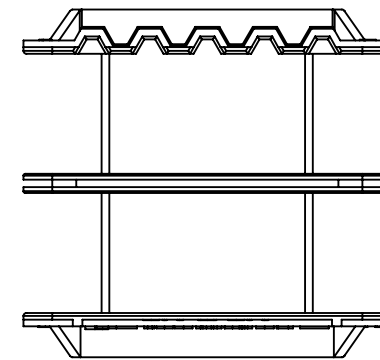
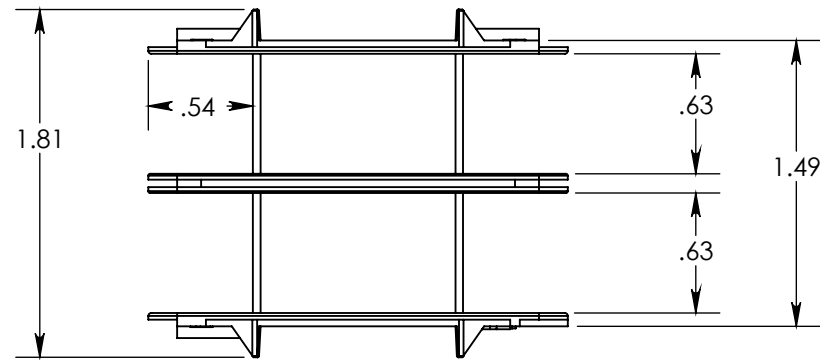
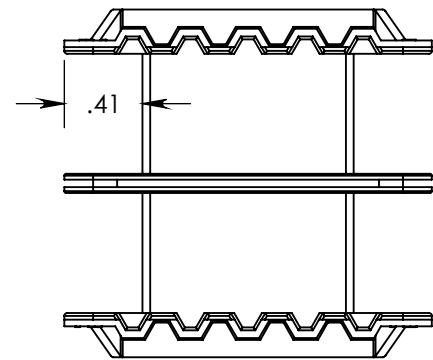
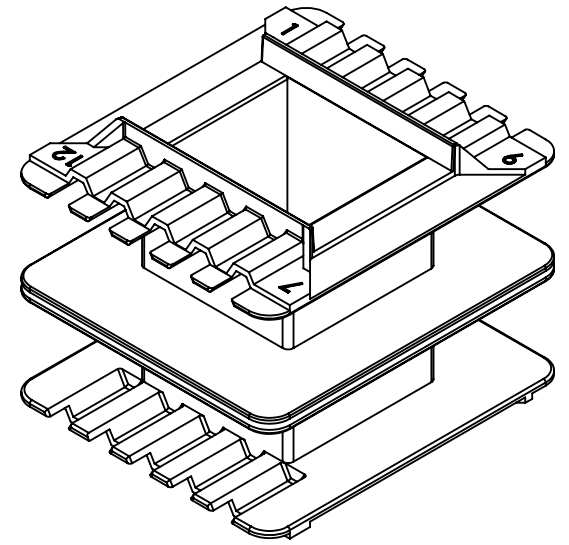
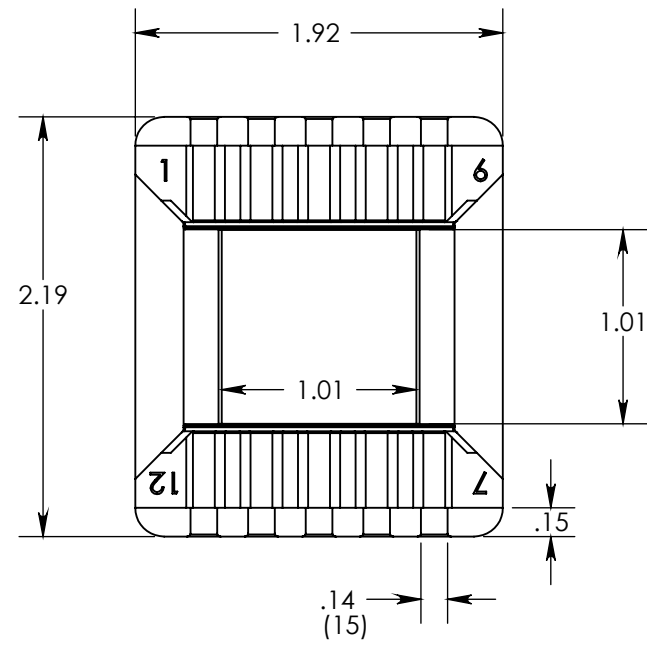

All dimensions for reference only. Samples available upon request.
 Foremost Plastic Products Company, inc. Phone 1-708-452-5300
 E-Mail: sales@foremostplastic.com Fax 1-708-452-0446