

EI 100 x 1-1/4
5-6079

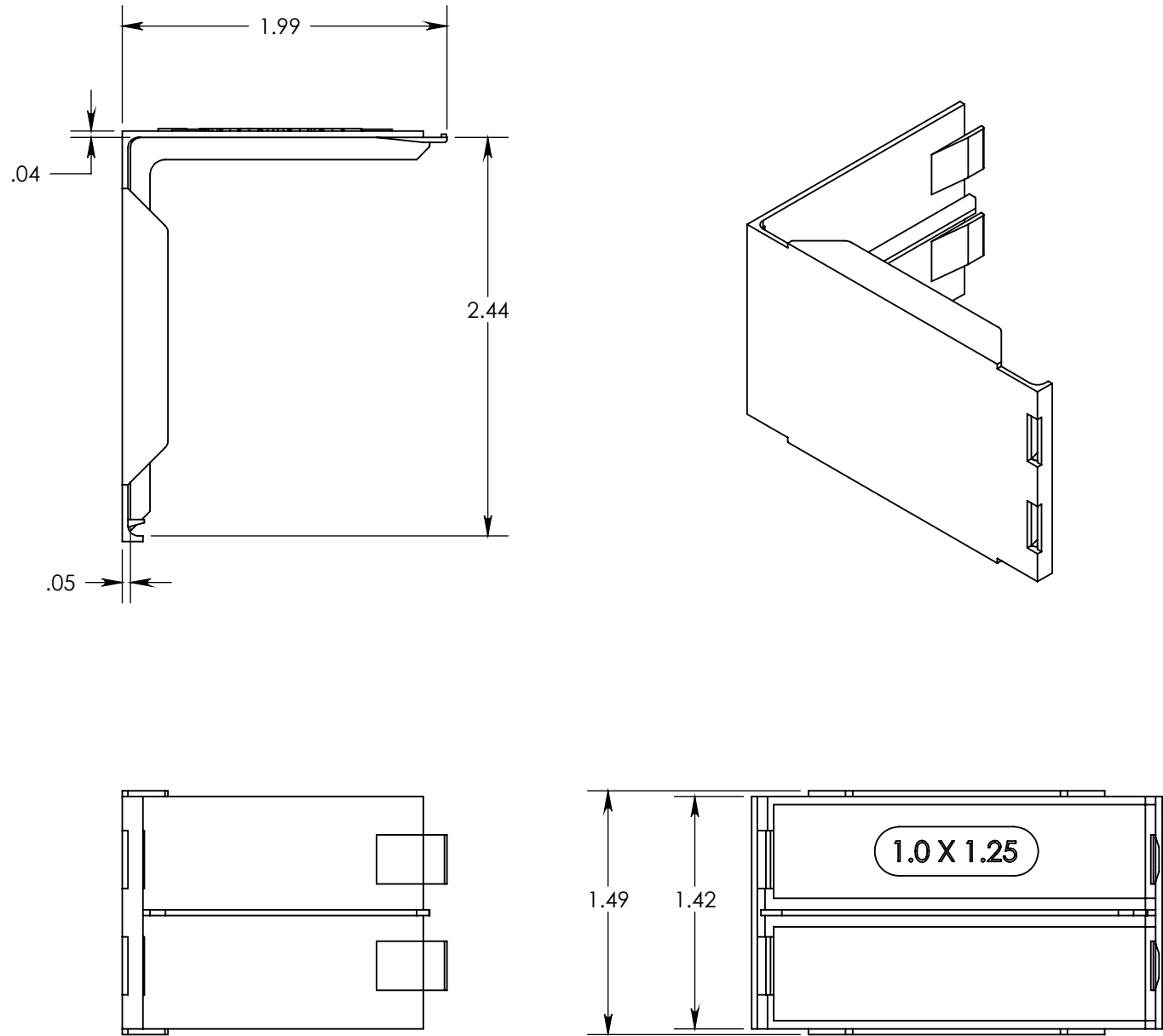

5-6077 and 6079
assembled

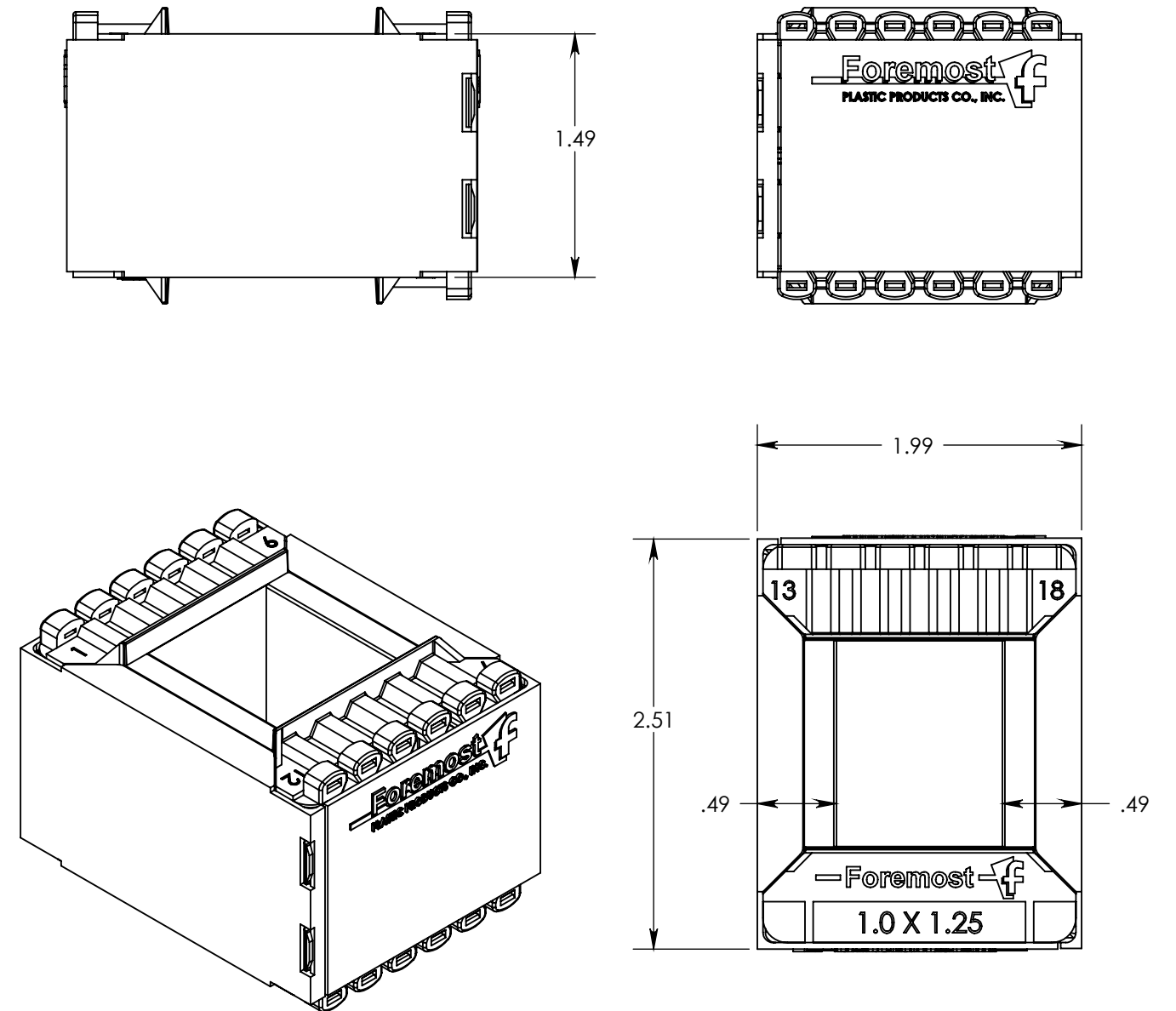

All dimensions for reference only. Samples available upon request.
Foremost Plastic Products Company, inc. Phone 1-708-452-5300
E-Mail: sales@foremostplastic.com Fax 1-708-452-0446