

EI 100 x 1-1/2  
 5-6082 SL-SDS  
 Slotted, Split Double Section

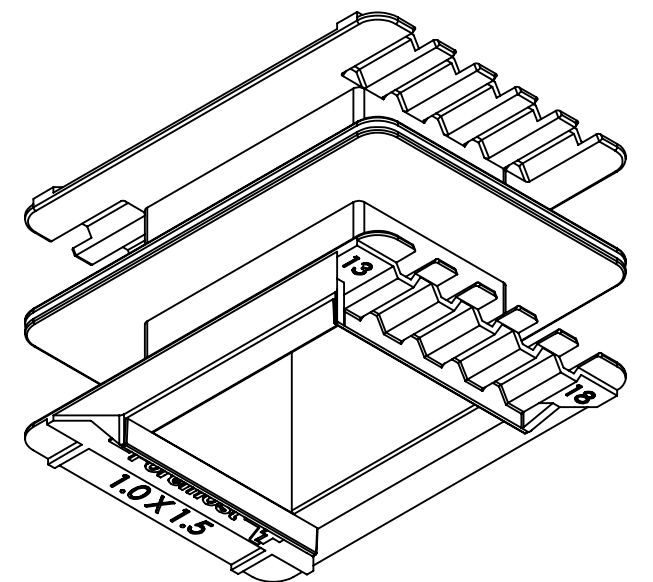
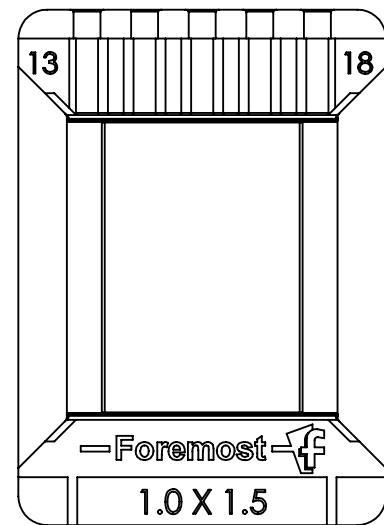
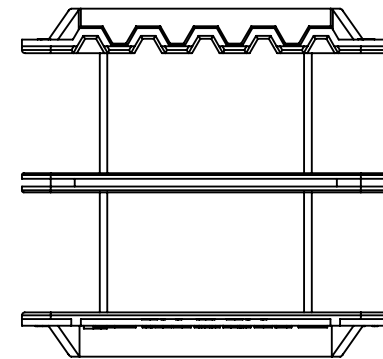
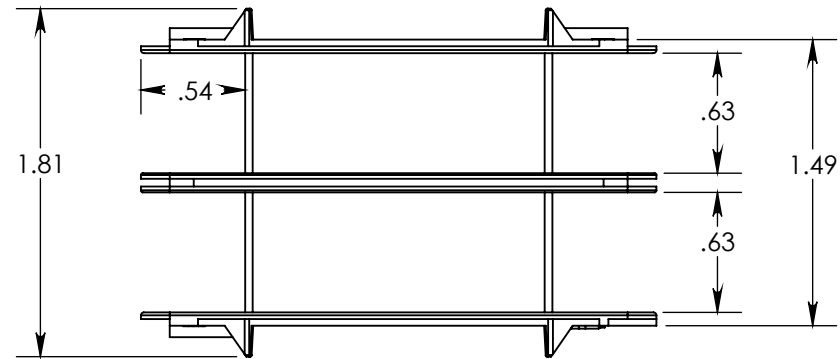
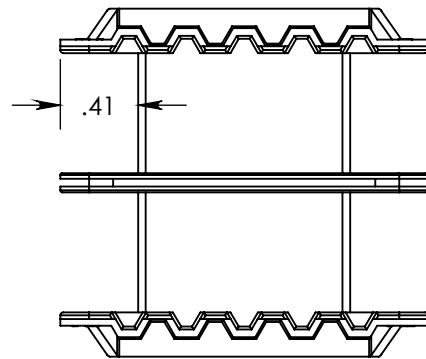
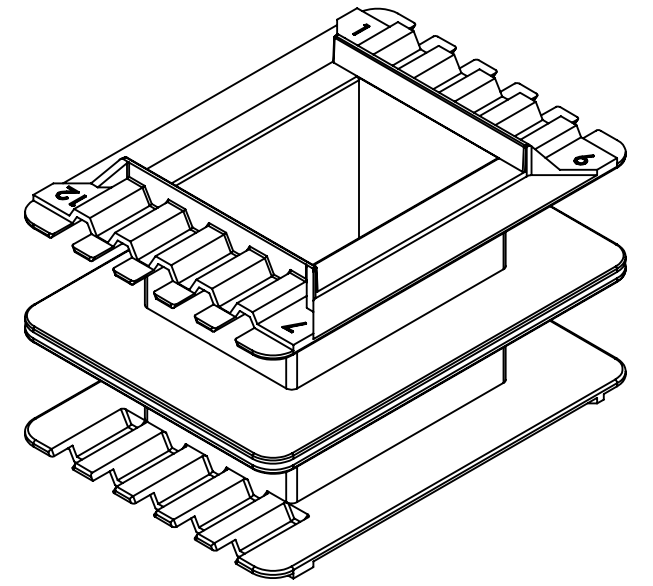
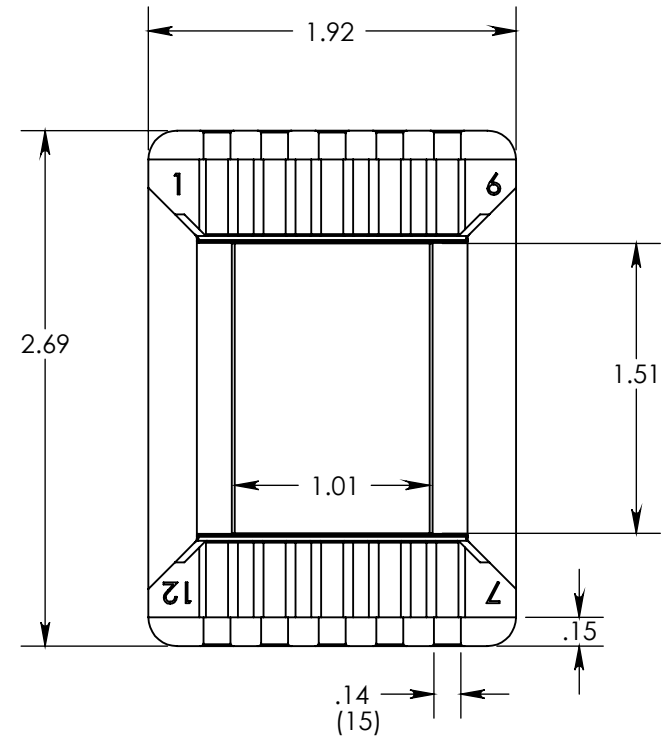

All dimensions for reference only. Samples available upon request.  
 Foremost Plastic Products Company, inc. Phone 1-708-452-5300  
 E-Mail: sales@foremostplastic.com Fax 1-708-452-0446