

EI 100 x 1-1/2
5-6089

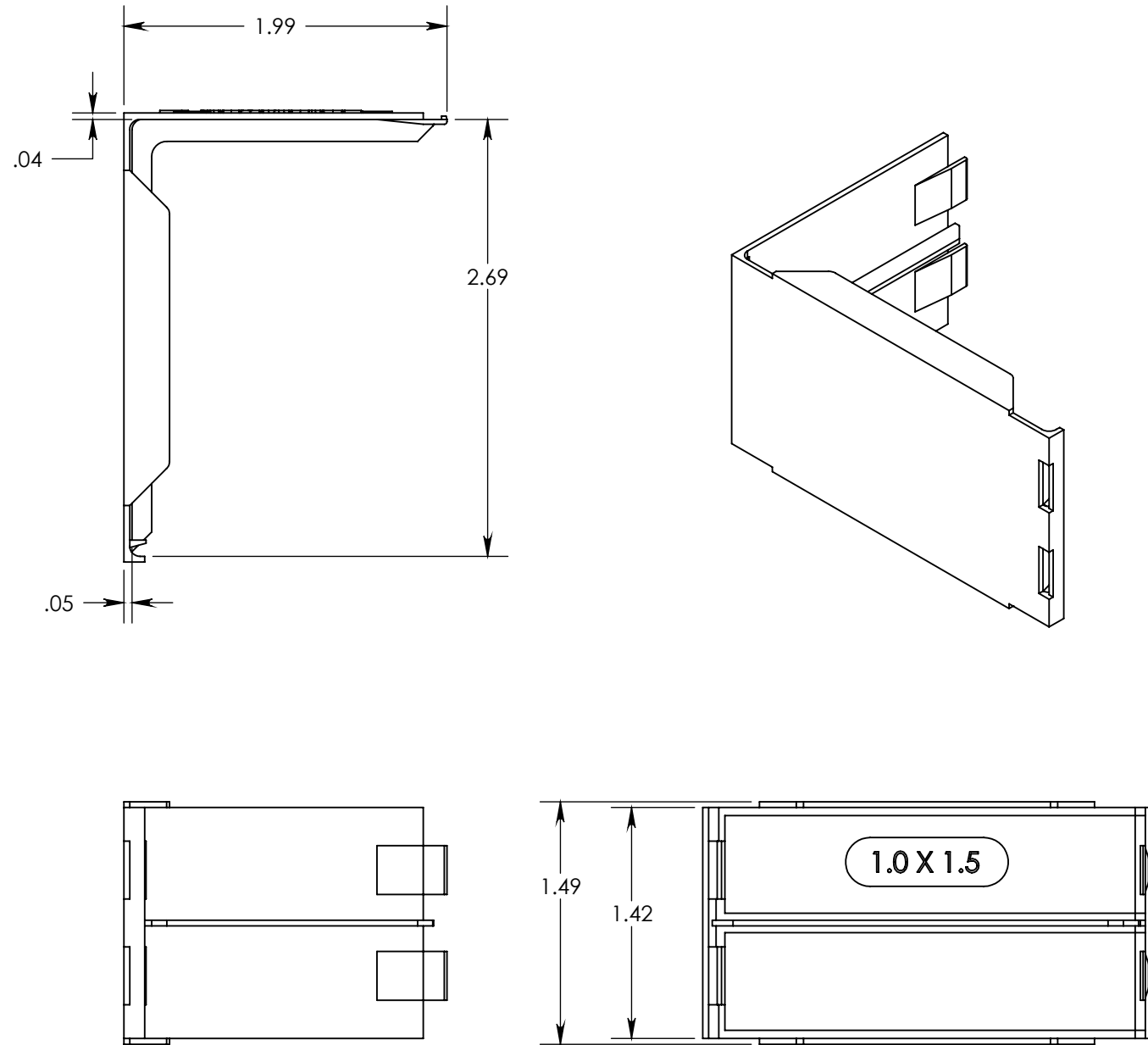

5-6087 and 6089
assembled

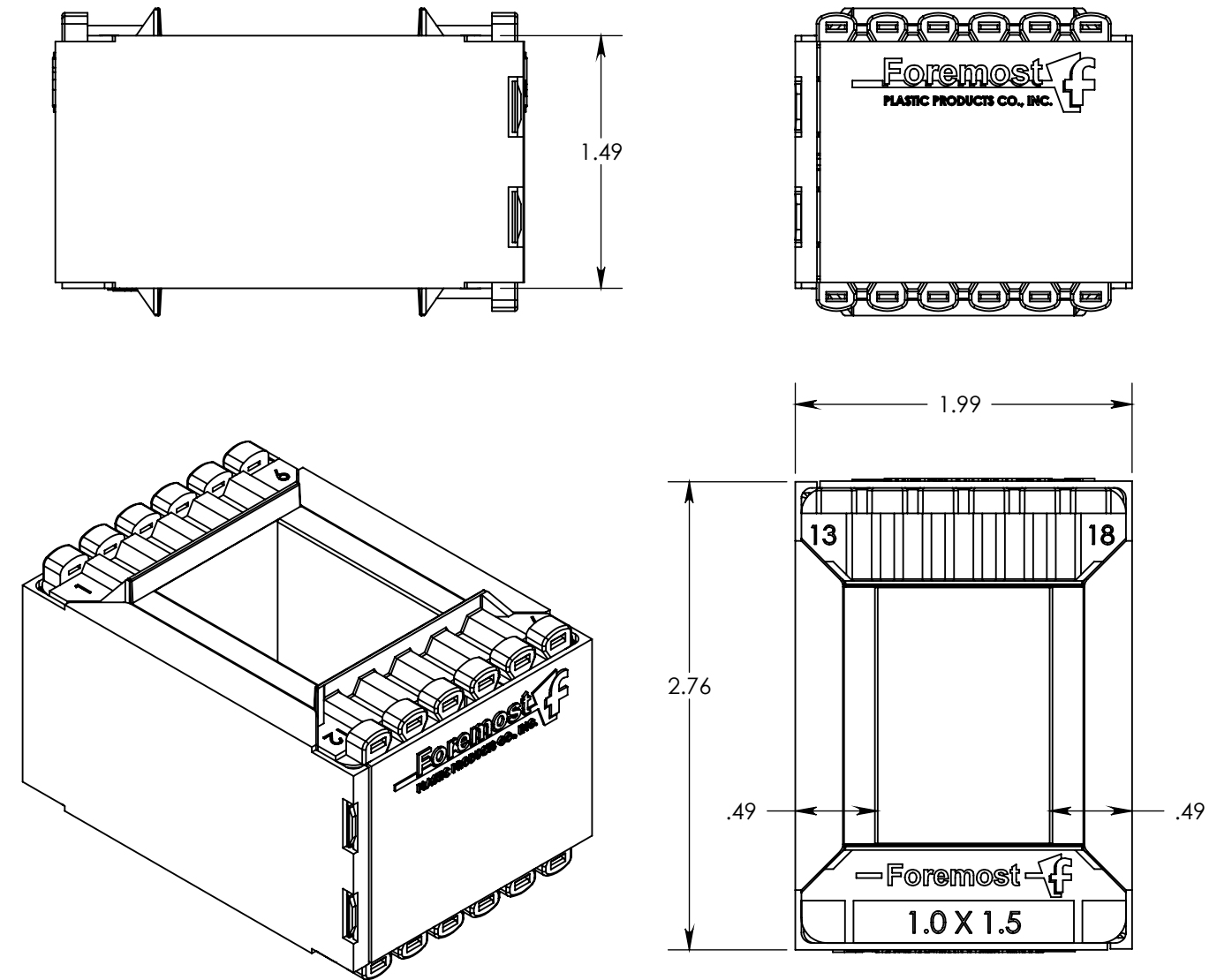

All dimensions for reference only. Samples available upon request.
Foremost Plastic Products Company, inc. Phone 1-708-452-5300
E-Mail: sales@foremostplastic.com Fax 1-708-452-0446