

EI 100 x 1-1/4  
 A-6074 T-SS P-900X  
 Terminated, **Single Section**

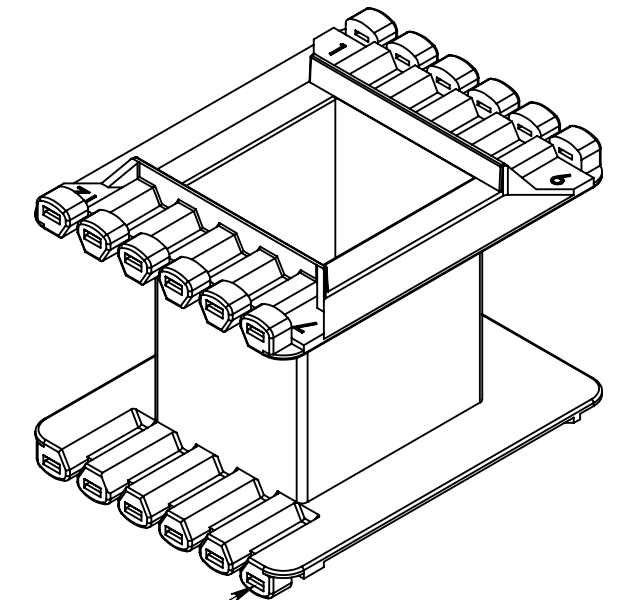

18 pin pockets accepting:  
 Solder terminal (P-9002)  
 PC terminal (P-9003)  
 .110 disconnect (P-9009)

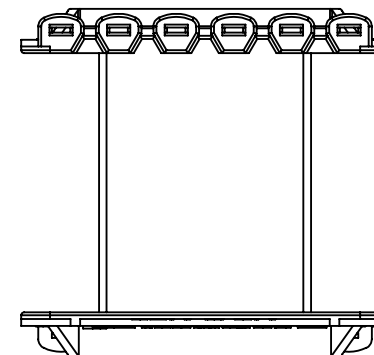
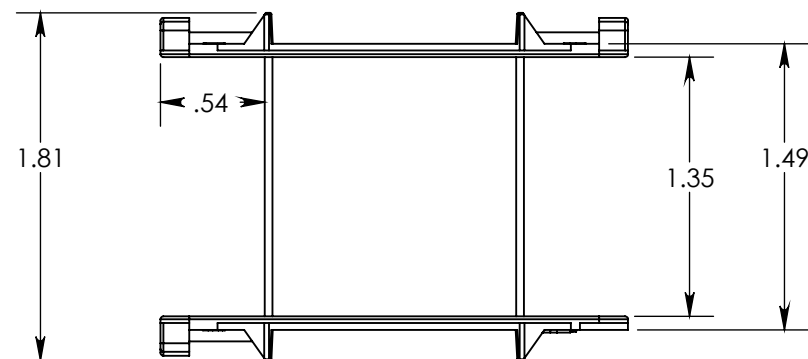
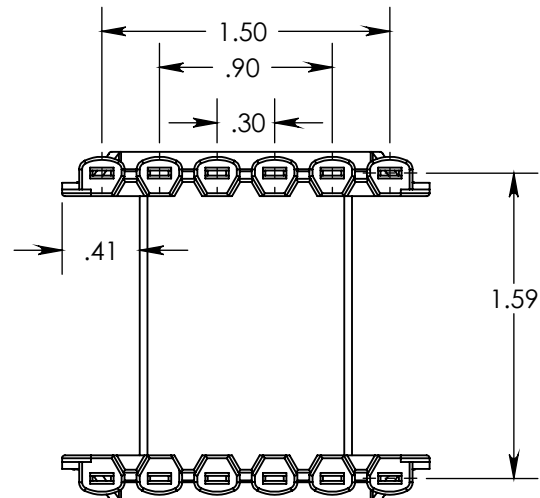
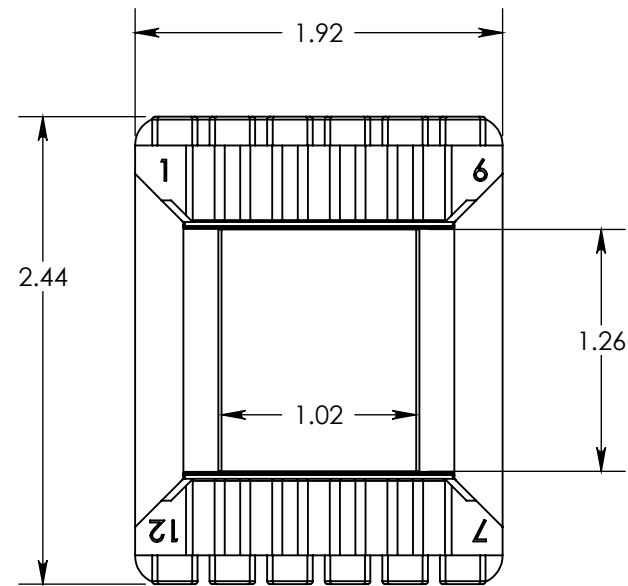
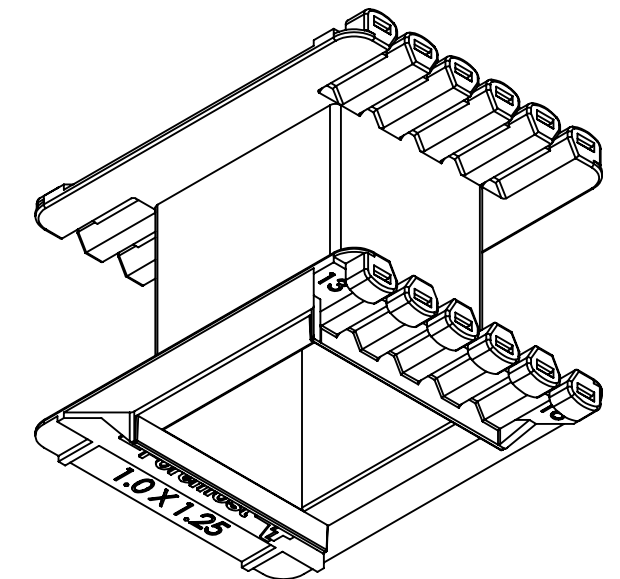
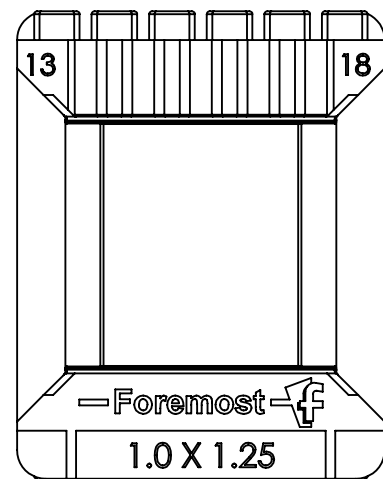

All dimensions for reference only. Samples available upon request.  
 Foremost Plastic Products Company, inc. Phone 1-708-452-5300  
 E-Mail: sales@foremostplastic.com Fax 1-708-452-0446