

EI 100 x 1-1/2
 A-6086 T-DS P-900X
 Terminated, **Double Section**

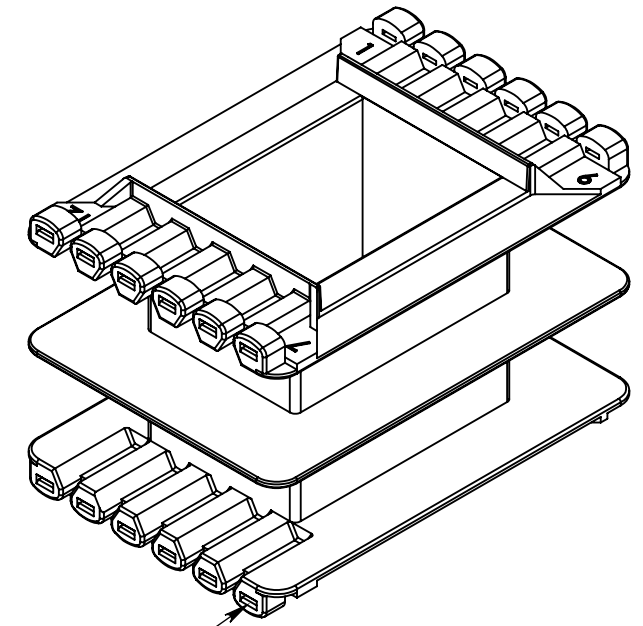

18 Pin pockets accepting:
 Solder terminal (P-9002)
 PC terminal (P-9003)
 .110 disconnect (P-9009)

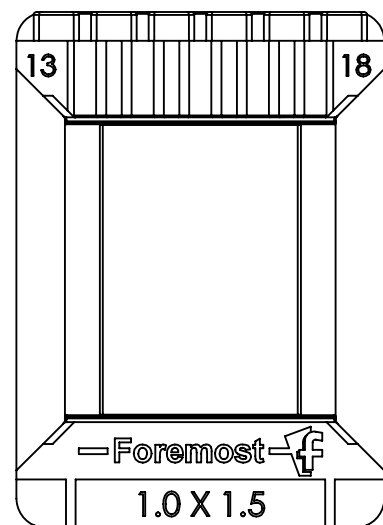
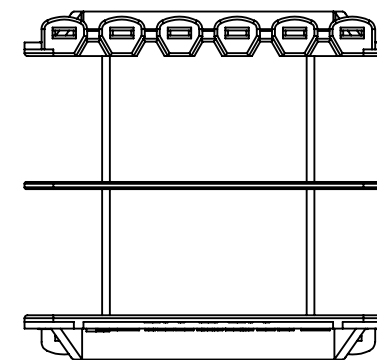
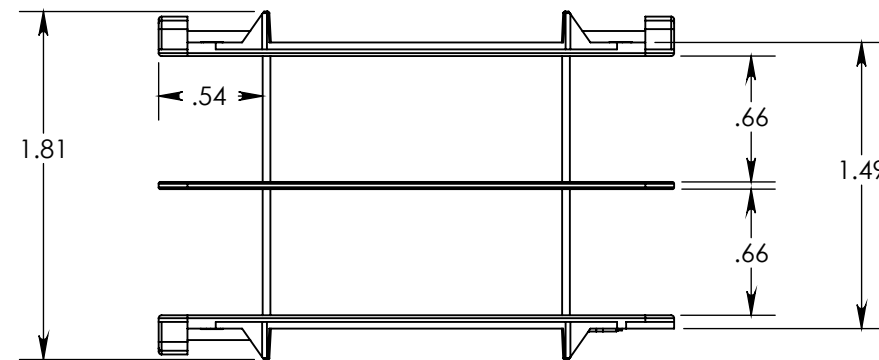
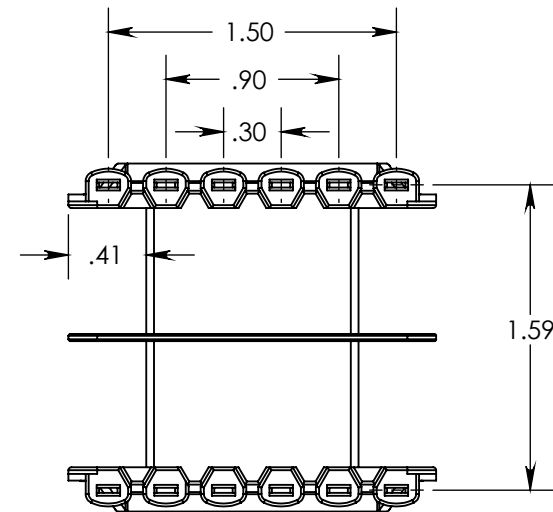
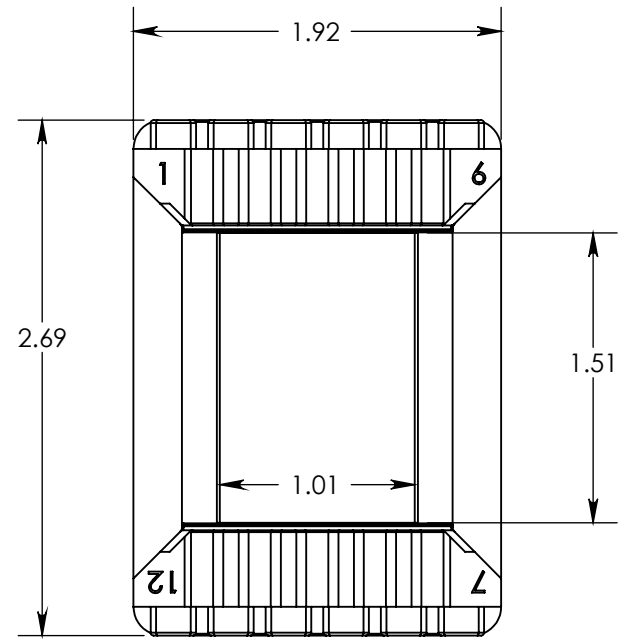
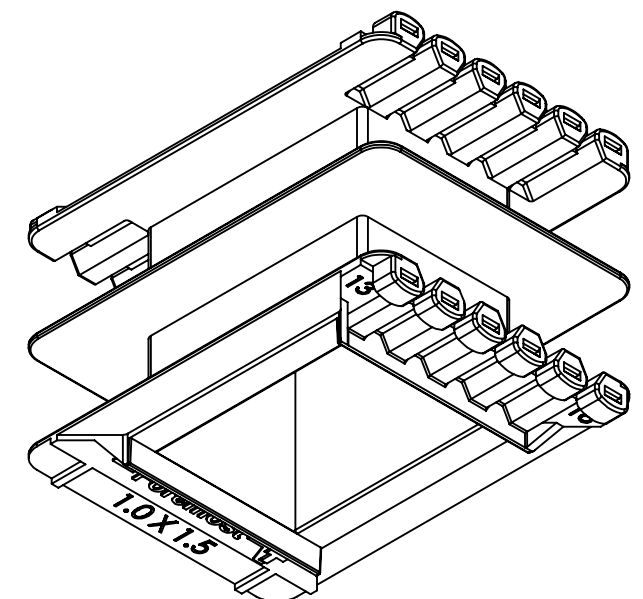

All dimensions for reference only. Samples available upon request.
 Foremost Plastic Products Company, inc. Phone 1-708-452-5300
 E-Mail: sales@foremostplastic.com Fax 1-708-452-0446